



Standardlock double-bit key system



Standardlock double-bit key system

OPERATION

- With its CISA-patented “independent key bitting” system and variable distance between the apexes of two opposite bitting depths, this lock guarantees extra security compared to traditional locks with “fixed bit distance”, easier to tamper with.
- The double-bit key operates the 6 anti-friction levers arranged in two sets, separated by the dead-bolt tang, each lever being activated by an independent helical spring.
- With the double-bit 6 lever CISA system, up to 244 million key differs are possible.

SECURITY

- Coupled with special manganese steel guard assembly plates (item 06429.50.0) the Standardlock System is rated a top security product by the European Standard UNI-EN 12209:03.

AVAILABLE MODELS

- With and without latch-bolt, with electrically operated latch-bolt, with construction key (operating the latch-bolt) for installers and construction workers, with service key (controlling 2 throws) with front locking or three locking points.
- Double lock version (Multifunction double-bit/cylinder, double-bit/double-bit): 2 locks, coupled to obtain a single product

performing different functions for enhanced handiness and security.

RANGE

- Developed according to 2 dimensional standards to meet any installation requirements.

CERTIFICATES

All CISA double-bit 6-lever locks have been designed and tested to meet the strictest requirements provided for by the Draft European Standard UNI EN 12209:03.

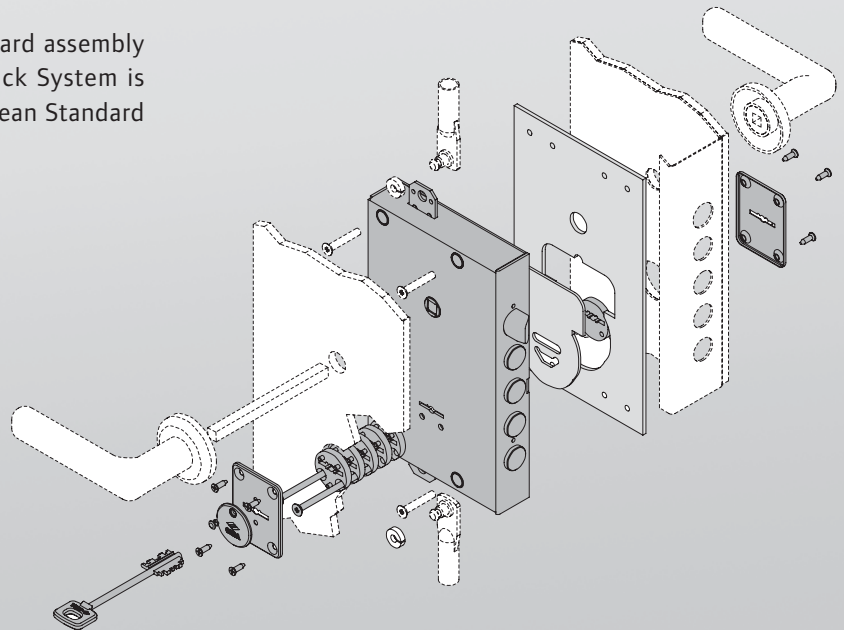



Technical features:

- Steel case and cover.
- Nickel-plated steel faceplate (mortice locks).
- Nickel-plated steel dead-bolts, 4 throws.
- Non-handed nickel-plated latch-bolt.
- Anti-picking latch-bolt (electrically operated locks).
- Nickel-plated reloading pin (electrically operated locks).
- Coil set with built-in terminal block, 12 V, 15 W ac (electrically operated locks).
- Anti-crush plates for screw fixing.
- Steel active pins.
- Packaging: 1 or 5 pieces (industrial packs).

Operation:

- From the inside: the latch-bolt can be remotely controlled (electrically controlled locks) or key- or handle-operated; the dead-bolts are key-operated.
- From the outside: the latch-bolt and dead-bolts are operated with the key.
- VERSION WITH CONSTRUCTION KEY:
 - The key operates the latch-bolt.
- VERSION WITH SERVICE KEY:
 - The key operates the latch-bolt and the first two throws.

Finishes:

- Zinc plated aluminium.

R./L. Hand Opening:

0 = non-handed.









Standard equipment:

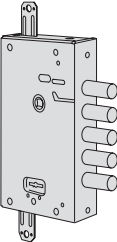
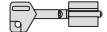



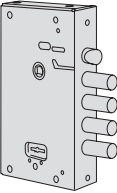
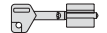

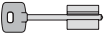



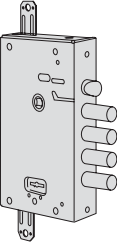

- Keys.
- Inside escutcheon item 1.06143.00.0, outside escutcheon item 1.06082.00.0, key guide item 1.06142.01.0 (rim locks).
- Inside escutcheon item 1.06143.00.0, item 1.06082.00.0 (mortice locks).





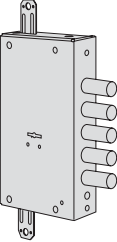

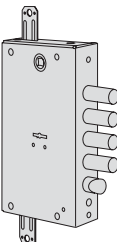

On request:

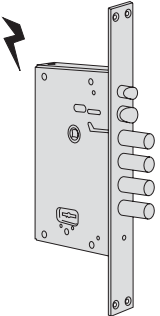

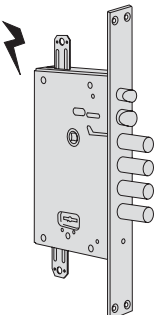

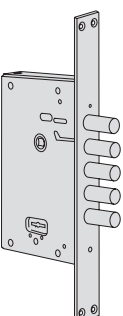

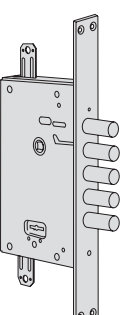



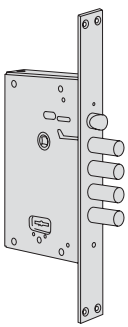





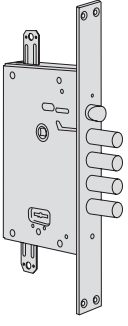

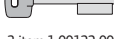

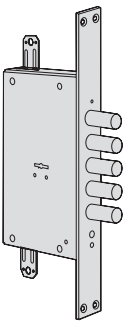

- Roses series 06144, 06145.
- Mounting plates series 06429.

| Type | Description | Item key | Dead-bolts | | | | | | | | | | ITEM | | | | |
|------------------|--|-------------------------|-------------------------|------------|----------|--------|----------|-----------|---------|-------------------|---------------------|---------------------|------|------|------|-------|-------|
| | | | No. | Projection | Distance | Throws | Distance | Faceplate | Backset | Unit weight Kg | Pieces | Type | Dim. | Hard | Fin. | Pers. | Spec. |
| | <ul style="list-style-type: none"> • Latch-bolt and dead-bolt • Electrically controlled dead-locking latch-bolt • Voltage: 12 V ac CE • Slide item 1.06224.50.0 | 3 item 1 00123 00 1 | 4 | 3,5 | 25 | 4 | 85 | - | 64 | 2,380 | 1 | 1 17510 25 0 | | | | | |
| | | | 4 | 3,5 | 27 | 4 | 85 | - | 64 | 2,380 | 1 | 1 17510 27 0 | | | | | |
| | | | 4 | 3,5 | 28 | 4 | 85 | - | 64 | 2,380 | 1 | 1 17510 28 0 | | | | | |
| | | | 3 | 3,5 | 32 | 4 | 85 | - | 64 | 2,380 | 1 | 1 17510 32 0 | | | | | |
| | | | 3 | 3,5 | 38 | 4 | 85 | - | 64 | 2,380 | 1 | 1 17510 38 0 | | | | | |
| | | | 4 | 3,5 | 25 | 4 | 85 | - | 64 | 2,080 | 5 | 1 17510 45 0 | | | | | |
| | | | 4 | 3,5 | 27 | 4 | 85 | - | 64 | 2,080 | 5 | 1 17510 47 0 | | | | | |
| | | | 4 | 3,5 | 28 | 4 | 85 | - | 64 | 2,080 | 5 | 1 17510 48 0 | | | | | |
| | | | 3 | 3,5 | 32 | 4 | 85 | - | 64 | 2,080 | 5 | 1 17510 52 0 | | | | | |
| | | | 3 | 3,5 | 38 | 4 | 85 | - | 64 | 2,080 | 5 | 1 17510 58 0 | | | | | |
| | <ul style="list-style-type: none"> • Latch-bolt and dead-bolt • Electrically controlled dead-locking latch-bolt • Voltage: 12 V ac CE • Slide item 1.06224.50.0 • Pre-setting for additional locking points | 3 item 1 00123 00 1 | 4 | 3,5 | 25 | 4 | 85 | - | 64 | 2,570 | 1 | 1 17515 25 0 | | | | | |
| | | | 4 | 3,5 | 27 | 4 | 85 | - | 64 | 2,570 | 1 | 1 17515 27 0 | | | | | |
| | | | 4 | 3,5 | 28 | 4 | 85 | - | 64 | 2,570 | 1 | 1 17515 28 0 | | | | | |
| | | | 3 | 3,5 | 32 | 4 | 85 | - | 64 | 2,570 | 1 | 1 17515 32 0 | | | | | |
| | | | 3 | 3,5 | 38 | 4 | 85 | - | 64 | 2,570 | 1 | 1 17515 38 0 | | | | | |
| | | | 4 | 3,5 | 25 | 4 | 85 | - | 64 | 2,270 | 5 | 1 17515 45 0 | | | | | |
| | | | 4 | 3,5 | 27 | 4 | 85 | - | 64 | 2,270 | 5 | 1 17515 47 0 | | | | | |
| | | | 4 | 3,5 | 28 | 4 | 85 | - | 64 | 2,270 | 5 | 1 17515 48 0 | | | | | |
| | | | 3 | 3,5 | 32 | 4 | 85 | - | 64 | 2,270 | 5 | 1 17515 52 0 | | | | | |
| | | | 3 | 3,5 | 38 | 4 | 85 | - | 64 | 2,270 | 5 | 1 17515 58 0 | | | | | |
| | • Dead-bolt only | 2 item 1 00125 00 1 | 5 | 3,5 | 28 | 4 | 85 | - | 64 | 2,180 | 1 | 1 57500 08 0 | | | | | |
| | | | 1 item 1 00120 00 1 | | | | | | | | | | | | | | |
| | • Dead-bolt only | 3 item 1 00123 00 1 | 5 | 3,5 | 25 | 4 | 85 | - | 64 | 2,180 | 1 | 1 57500 25 0 | | | | | |
| | | | 5 | 3,5 | 27 | 4 | 85 | - | 64 | 2,180 | 1 | 1 57500 27 0 | | | | | |
| | | | 5 | 3,5 | 28 | 4 | 85 | - | 64 | 2,180 | 1 | 1 57500 28 0 | | | | | |
| | | | 4 | 3,5 | 32 | 4 | 85 | - | 64 | 2,180 | 1 | 1 57500 32 0 | | | | | |
| | • VERSION WITH SERVICE KEY | 3 item 1 00123 00 1 | 5 | 3,5 | 25 | 4 | 85 | - | 64 | 2,200 | 1 | 1 57501 25 0 | | | | | |
| | | | 5 | 3,5 | 27 | 4 | 85 | - | 64 | 2,200 | 1 | 1 57501 27 0 | | | | | |
| | | | 5 | 3,5 | 28 | 4 | 85 | - | 64 | 2,200 | 1 | 1 57501 28 0 | | | | | |
| | | | 4 | 3,5 | 32 | 4 | 85 | - | 64 | 2,200 | 1 | 1 57501 32 0 | | | | | |
| • Dead-bolt only | 1 item 1 00120 00 1 service key | 4 | 3,5 | 38 | 4 | 85 | - | 64 | 2,200 | 1 | 1 57501 38 0 | | | | | | |
| | | | | | | | | | | | | | | | | | |
| • Dead-bolt only | 3 item 1 00123 00 1 | 5 | 43,5 | 28 | 4 | 85 | - | 64 | 2,380 | 1 | 1 57502 28 0 | | | | | | |
| | | 4 | 43,5 | 32 | 4 | 85 | - | 64 | 2,380 | 1 | 1 57502 32 0 | | | | | | |

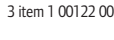
| Type | Description | Item key | Dead-bolts | | | | | | | Unit weight Kg | Pieces | ITEM | | | | | | | | |
|--|---|--|---|------------|----------|--------|----------|-----------|---------|-------------------|--------|------|------|------|------|-------|-------|--|--|--|
| | | | No. | Projection | Distance | Throws | Distance | Faceplate | Backset | | | Type | Dim. | Hard | Fin. | Pers. | Spec. | | | |
|  | <ul style="list-style-type: none"> • Dead-bolt only • Pre-setting for additional locking points |  5 3,5 28 4 85 - 64 2,280 1 1 57505 08 0 | | | | | | | | | | | | | | | | | | |
| | | 2 item 1 00125 00 1 | | | | | | | | | | | | | | | | | | |
| | | |  1 item 1 00120 00 1 | | | | | | | | | | | | | | | | | |
| | <ul style="list-style-type: none"> • Dead-bolt only • Pre-setting for additional locking points |  5 3,5 25 4 85 - 64 2,380 1 1 57505 25 0 | | | | | | | | | | | | | | | | | | |
| | | 5 3,5 27 4 85 - 64 2,380 1 1 57505 27 0 | | | | | | | | | | | | | | | | | | |
| | | 3 item 1 00123 00 1 | | | | | | | | | | | | | | | | | | |
| | | 5 3,5 28 4 85 - 64 2,380 1 1 57505 28 0 | | | | | | | | | | | | | | | | | | |
| | | 4 3,5 32 4 85 - 64 2,380 1 1 57505 32 0 | | | | | | | | | | | | | | | | | | |
| | | | 4 3,5 38 4 85 - 64 2,380 1 1 57505 38 0 | | | | | | | | | | | | | | | | | |
| | <ul style="list-style-type: none"> • VERSION WITH SERVICE KEY • Dead-bolt only • Pre-setting for additional locking points |  5 3,5 25 4 85 - 64 2,400 1 1 57506 25 0 | | | | | | | | | | | | | | | | | | |
| 5 3,5 27 4 85 - 64 2,400 1 1 57506 27 0 | | | | | | | | | | | | | | | | | | | | |
| 3 item 1 00123 00 1 | | | | | | | | | | | | | | | | | | | | |
| 5 3,5 28 4 85 - 64 2,400 1 1 57506 28 0 | | | | | | | | | | | | | | | | | | | | |
| 4 3,5 32 4 85 - 64 2,400 1 1 57506 32 0 | | | | | | | | | | | | | | | | | | | | |
| | | 4 3,5 38 4 85 - 64 2,400 1 1 57506 38 0 | | | | | | | | | | | | | | | | | | |
| | | 1 item 1 00120 00 1 service key | | | | | | | | | | | | | | | | | | |
| <ul style="list-style-type: none"> • Dead-bolt only • Pre-setting for additional locking points • Cover plate item 1.06228.00.0 |  5 43,5 28 4 85 - 64 2,580 1 1 57507 28 0 | | | | | | | | | | | | | | | | | | | |
| | 3 item 1 00123 00 1 | | | | | | | | | | | | | | | | | | | |
|  | <ul style="list-style-type: none"> • Latch-bolt and dead-bolt |  4 3,5 28 4 85 - 64 2,850 1 1 57510 08 0 | | | | | | | | | | | | | | | | | | |
| | | 2 item 1 00125 00 1 | | | | | | | | | | | | | | | | | | |
| | | |  1 item 1 00120 00 1 | | | | | | | | | | | | | | | | | |
| | <ul style="list-style-type: none"> • Latch-bolt and dead-bolt |  4 3,5 25 4 85 - 64 2,230 1 1 57510 25 0 | | | | | | | | | | | | | | | | | | |
| | | 4 3,5 27 4 85 - 64 2,230 1 1 57510 27 0 | | | | | | | | | | | | | | | | | | |
| | | 3 item 1 00123 00 1 | | | | | | | | | | | | | | | | | | |
| | | 4 3,5 28 4 85 - 64 2,230 1 1 57510 28 0 | | | | | | | | | | | | | | | | | | |
| | | 3 3,5 32 4 85 - 64 2,230 1 1 57510 32 0 | | | | | | | | | | | | | | | | | | |
| | | | 3 3,5 38 4 85 - 64 2,230 1 1 57510 38 0 | | | | | | | | | | | | | | | | | |
| | <ul style="list-style-type: none"> • VERSION WITH SERVICE KEY • Latch-bolt and dead-bolt |  4 3,5 25 4 85 - 64 2,250 1 1 57511 25 0 | | | | | | | | | | | | | | | | | | |
| 4 3,5 27 4 85 - 64 2,250 1 1 57511 27 0 | | | | | | | | | | | | | | | | | | | | |
| 3 item 1 00123 00 1 | | | | | | | | | | | | | | | | | | | | |
| 4 3,5 28 4 85 - 64 2,250 1 1 57511 28 0 | | | | | | | | | | | | | | | | | | | | |
| 3 3,5 32 4 85 - 64 2,250 1 1 57511 32 0 | | | | | | | | | | | | | | | | | | | | |
| | | 3 3,5 38 4 85 - 64 2,250 1 1 57511 38 0 | | | | | | | | | | | | | | | | | | |
| | | 1 item 1 00120 00 1 service key | | | | | | | | | | | | | | | | | | |
| <ul style="list-style-type: none"> • Latch-bolt and dead-bolt • Cover plate item 1.06228.00.0 |  4 43,5 28 4 85 - 64 2,430 1 1 57512 28 0 | | | | | | | | | | | | | | | | | | | |
| | 3 43,5 32 4 85 - 64 2,430 1 1 57512 32 0 | | | | | | | | | | | | | | | | | | | |
| | | 3 item 1 00123 00 1 | | | | | | | | | | | | | | | | | | |

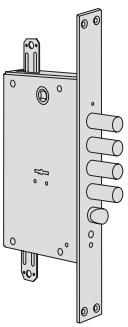
| Type | Description | Item key | Dead-bolts | | | | | | | | ITEM | | | | | | |
|--|--|---|--------------------------------------|------------|----------|--------|----------|-----------|---------|---------------------|---------------------|---------------------|--------------|------|-------|-------|--|
| | | | No. | Projection | Distance | Throws | Distance | Faceplate | Backset | Unit weight Kg | Pieces | Type | Dim. Hand | Fin. | Pers. | Spec. | |
|  | <ul style="list-style-type: none"> Latch-bolt and dead-bolt Pre-setting for additional locking points |  | 4 | 3,5 | 28 | 4 | 85 | - | 64 | 2,430 | 1 | 1 57515 08 0 | | | | | |
| | | 2 item 1 00125 00 1 | | | | | | | | | | | | | | | |
| | <ul style="list-style-type: none"> Latch-bolt and dead-bolt Pre-setting for additional locking points |  | 4 | 3,5 | 25 | 4 | 85 | - | 64 | 2,430 | 1 | 1 57515 25 0 | | | | | |
| | | 3 item 1 00123 00 1 | 4 | 3,5 | 27 | 4 | 85 | - | 64 | 2,600 | 1 | 1 57515 27 0 | | | | | |
| | | 4 | 3,5 | 28 | 4 | 85 | - | 64 | 2,430 | 1 | 1 57515 28 0 | | | | | | |
| | | 3 | 3,5 | 32 | 4 | 85 | - | 64 | 2,430 | 1 | 1 57515 32 0 | | | | | | |
| | | 3 | 3,5 | 38 | 4 | 85 | - | 64 | 2,430 | 1 | 1 57515 38 0 | | | | | | |
| | | 4 | 3,5 | 28 | 4 | 85 | - | 64 | 2,260 | 5 | 1 57515 48 0 | | | | | | |
| | <ul style="list-style-type: none"> VERSION WITH CONSTRUCTION KEY Latch-bolt and dead-bolt Pre-setting for additional locking points |  | 4 | 3,5 | 28 | 4 | 85 | - | 64 | 2,450 | 1 | 1 57515 68 0 | | | | | |
| | | 3 item 1 00123 00 1 | 1 item 1 00120 00 1 construction key | | | | | | | | | | | | | | |
| <ul style="list-style-type: none"> VERSION WITH SERVICE KEY Latch-bolt and dead-bolt Pre-setting for additional locking points |  | 4 | 3,5 | 25 | 4 | 85 | - | 64 | 2,450 | 1 | 1 57516 25 0 | | | | | | |
| | 3 item 1 00123 00 1 | 4 | 3,5 | 27 | 4 | 85 | - | 64 | 2,450 | 1 | 1 57516 27 0 | | | | | | |
| | 4 | 3,5 | 28 | 4 | 85 | - | 64 | 2,450 | 1 | 1 57516 28 0 | | | | | | | |
| |  | 3 | 3,5 | 32 | 4 | 85 | - | 64 | 2,450 | 1 | 1 57516 32 0 | | | | | | |
| | 1 item 1 00120 00 1 service key | 3 | 3,5 | 38 | 4 | 85 | - | 64 | 2,450 | 1 | 1 57516 38 0 | | | | | | |
| <ul style="list-style-type: none"> Latch-bolt and dead-bolt Pre-setting for additional locking points Cover plate item 1.06228.00.0 |  | 4 | 43,5 | 28 | 4 | 85 | - | 64 | 2,630 | 1 | 1 57517 28 0 | | | | | | |
| | 3 item 1 00123 00 1 | 3 | 43,5 | 32 | 4 | 85 | - | 64 | 2,630 | 1 | 1 57517 32 0 | | | | | | |
| | 3 | 43,5 | 38 | 4 | 85 | - | 64 | 2,630 | 1 | 1 57517 38 0 | | | | | | | |
| | | | | | | | | | | | | | | | | | |
| <ul style="list-style-type: none"> VERSION WITH SERVICE KEY Latch-bolt and dead-bolt Pre-setting for additional locking points Cover plate item 1.06228.00.0 |  | 3 | 43,5 | 32 | 4 | 85 | - | 64 | 2,650 | 1 | 1 57518 32 0 | | | | | | |
| | 3 item 1 00123 00 1 | 1 item 1 00120 00 1 service key | | | | | | | | | | | | | | | |
| | | | | | | | | | | | | | | | | | |
|  | <ul style="list-style-type: none"> Dead-bolt only Pre-setting for additional locking points |  | 5 | 3,5 | 25 | 4 | 85 | - | 64 | 2,370 | 1 | 1 B7505 25 0 | | | | | |
| | | 3 item 1 00123 00 1 | 5 | 3,5 | 28 | 4 | 85 | - | 64 | 2,370 | 1 | 1 B7505 28 0 | | | | | |
| | <ul style="list-style-type: none"> Pre-setting for additional locking points | 4 | 3,5 | 38 | 4 | 85 | - | 64 | 2,370 | 1 | 1 B7505 38 0 | | | | | | |
| | | 5 | 3,5 | 25 | 4 | 85 | - | 64 | 2,070 | 5 | 1 B7505 45 0 | | | | | | |
| | | 5 | 3,5 | 28 | 4 | 85 | - | 64 | 2,070 | 5 | 1 B7505 48 0 | | | | | | |
| | | 4 | 3,5 | 38 | 4 | 85 | - | 64 | 2,070 | 5 | 1 B7505 58 0 | | | | | | |
|  | <ul style="list-style-type: none"> Latch-bolt and dead-bolt Pre-setting for additional locking points |  | 4 | 3,5 | 25 | 4 | 85 | - | 64 | 2,320 | 1 | 1 B7515 25 0 | | | | | |
| | | 3 item 1 00123 00 1 | 4 | 3,5 | 28 | 4 | 85 | - | 64 | 2,320 | 1 | 1 B7515 28 0 | | | | | |
| | <ul style="list-style-type: none"> Pre-setting for additional locking points | 3 | 3,5 | 38 | 4 | 85 | - | 64 | 2,320 | 1 | 1 B7515 38 0 | | | | | | |
| | | 4 | 3,5 | 25 | 4 | 85 | - | 64 | 2,020 | 5 | 1 B7515 45 0 | | | | | | |
| | | 4 | 3,5 | 28 | 4 | 85 | - | 64 | 2,360 | 5 | 1 B7515 48 0 | | | | | | |
| | | 3 | 3,5 | 38 | 4 | 85 | - | 64 | 2,020 | 5 | 1 B7515 58 0 | | | | | | |

| Type | Description | Item key | Dead-bolts | | | | | | | | ITEM | | | | | |
|---|--|--|------------|--------------|-------------|--------|----------|-----------|---------|-------------------|--------|---------------------|--------------|------|----------------|--|
| | | | No. | Projection | Distance | Throws | Distance | Faceplate | Backset | Unit weight Kg | Pieces | Type | Dim. Hand | Fin. | Pers. Spec. | |
|  | <ul style="list-style-type: none"> • Latch-bolt and dead-bolt • Electrically controlled dead-locking latch-bolt • Voltage: 12 V ac CE • Slide item 1.06224.50.0 |  3 item 1 00122 00 1 | 4 | - | 28 | 4 | 85 | 35 | 67 | 2,650 | 1 | 1 17530 28 0 | | | | |
| | | | 4 | - | 28 | 4 | 85 | 35 | 67 | 2,350 | 5 | 1 17530 48 0 | | | | |
|  | <ul style="list-style-type: none"> • Latch-bolt and dead-bolt • Electrically controlled dead-locking latch-bolt • Voltage: 12 V ac CE • Slide item 1.06224.50.0 • Pre-setting for additional locking points |  3 item 1 00122 00 1 | 4 | - | 28 | 4 | 85 | 35 | 67 | 2,840 | 1 | 1 17535 28 0 | | | | |
| | | | 4 | - | 28 | 4 | 85 | 35 | 67 | 2,540 | 5 | 1 17535 48 0 | | | | |
|  | <ul style="list-style-type: none"> • Dead-bolt only • VERSION WITH SERVICE KEY • Dead-bolt only |  3 item 1 00122 00 1 | 5 | - | 28 | 4 | 85 | 35 | 67 | 2,480 | 1 | 1 57520 28 0 | | | | |
| | | | 5 | - | 28 | 4 | 85 | 35 | 67 | 2,500 | 1 | 1 57521 28 0 | | | | |
| | | 1 | | 1 00121 00 1 | service key | | | | | | | | | | | |
|  | <ul style="list-style-type: none"> • Dead-bolt only • Pre-setting for additional locking points • VERSION WITH SERVICE KEY • Dead-bolt only • Pre-setting for additional locking points |  3 item 1 00122 00 1 | 5 | - | 28 | 4 | 85 | 35 | 67 | 2,580 | 1 | 1 57525 28 0 | | | | |
| | | | 5 | - | 28 | 4 | 85 | 35 | 67 | 2,600 | 1 | 1 57526 28 0 | | | | |
| | | 1 | | 1 00121 00 1 | service key | | | | | | | | | | | |

| Type | Description | Item key | Dead-bolts | | | | | | | | Unit weight | | ITEM | | | | |
|---|--|---|---|---------------------|----------|--------|----------|-----------|---------|----|-------------|------|------|------|------|-------|-------|
| | | | No. | Projection | Distance | Throws | Distance | Faceplate | Backset | Kg | Pieces | Type | Dim. | Hand | Fin. | Pers. | Spec. |
|  | <ul style="list-style-type: none"> Latch-bolt and dead-bolt |  4 - 28 4 85 35 67 2,680 1 | 1 57530 28 0 | | | | | | | | | | | | | | |
| | | 3 item 1 00122 00 1 | | | | | | | | | | | | | | | |
| | <ul style="list-style-type: none"> VERSION WITH CONSTRUCTION KEY Latch-bolt and dead-bolt |  4 - 28 4 85 35 67 2,700 1 | 1 57530 88 0 | | | | | | | | | | | | | | |
| | | 3 item 1 00122 00 1 | | | | | | | | | | | | | | | |
| | <ul style="list-style-type: none"> VERSION WITH SERVICE KEY Latch-bolt and dead-bolt |  1 item 1 00121 00 1 | | | | | | | | | | | | | | | |
| | | construction key | | | | | | | | | | | | | | | |
| <ul style="list-style-type: none"> VERSION WITH SERVICE KEY Latch-bolt and dead-bolt |  4 - 28 4 85 35 67 2,700 1 | 1 57531 28 0 | | | | | | | | | | | | | | | |
| | 3 item 1 00122 00 1 | | | | | | | | | | | | | | | | |
| | |  1 item 1 00121 00 1 | | | | | | | | | | | | | | | |
| | | service key | | | | | | | | | | | | | | | |
|  | <ul style="list-style-type: none"> Latch-bolt and dead-bolt Pre-setting for additional locking points |  4 - 28 4 85 35 67 2,780 1 | 1 57535 28 0 | | | | | | | | | | | | | | |
| | | 3 item 1 00122 00 1 |  4 - 28 4 85 35 67 2,500 5 | 1 57535 48 0 | | | | | | | | | | | | | |
| | <ul style="list-style-type: none"> VERSION WITH CONSTRUCTION KEY Latch-bolt and dead-bolt Pre-setting for additional locking points |  4 - 28 4 85 35 67 2,520 1 | 1 57535 68 0 | | | | | | | | | | | | | | |
| | | 3 item 1 00122 00 1 |  4 - 28 4 85 35 67 2,800 5 | 1 57535 88 0 | | | | | | | | | | | | | |
| | <ul style="list-style-type: none"> VERSION WITH SERVICE KEY Latch-bolt and dead-bolt Pre-setting for additional locking points |  1 item 1 00121 00 1 | | | | | | | | | | | | | | | |
| | | construction key | | | | | | | | | | | | | | | |
| <ul style="list-style-type: none"> VERSION WITH SERVICE KEY Latch-bolt and dead-bolt Pre-setting for additional locking points |  5 - 28 4 85 35 67 2,520 1 | 1 57536 28 0 | | | | | | | | | | | | | | | |
| | 3 item 1 00122 00 1 | | | | | | | | | | | | | | | | |
| | |  1 item 1 00121 00 1 | | | | | | | | | | | | | | | |
| | | service key | | | | | | | | | | | | | | | |
|  | <ul style="list-style-type: none"> Dead-bolt only Pre-setting for additional locking points |  5 - 28 4 85 35 67 2,650 1 | 1 B7525 28 0 | | | | | | | | | | | | | | |
| | | 3 item 1 00122 00 1 |  4 - 38 4 85 35 67 2,650 1 | 1 B7525 38 0 | | | | | | | | | | | | | |
| | | |  5 - 28 4 85 35 67 2,350 5 | 1 B7525 48 0 | | | | | | | | | | | | | |
| | | |  4 - 38 4 85 35 67 2,350 5 | 1 B7525 58 0 | | | | | | | | | | | | | |
| | | | | | | | | | | | | | | | | | |
|  | <ul style="list-style-type: none"> Latch-bolt and dead-bolt Pre-setting for additional locking points |  4 - 28 4 85 35 67 2,800 1 | 1 B7535 28 0 | | | | | | | | | | | | | | |
| | | 3 art. 1 00122 00 1 |  3 - 38 4 85 35 67 2,800 1 | 1 B7535 38 0 | | | | | | | | | | | | | |
| | | |  4 - 28 4 85 35 67 2,300 5 | 1 B7535 48 0 | | | | | | | | | | | | | |
| | | |  3 - 38 4 85 35 67 2,300 5 | 1 B7535 58 0 | | | | | | | | | | | | | |
| | | | | | | | | | | | | | | | | | |

Drawings and dimensions

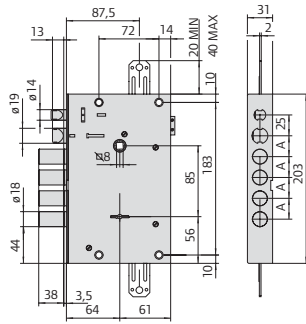

15510, 15515
A = 25 - 27 - 28 - 32 - 38

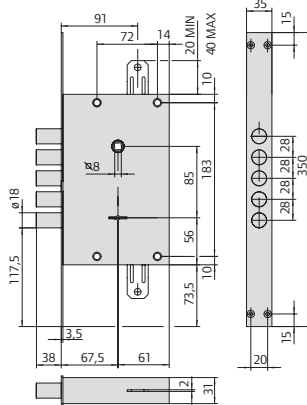

57520, 57521, 57525, 57526

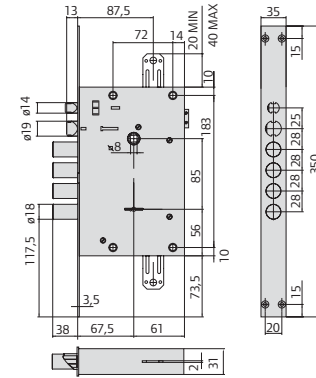

17530, 17535

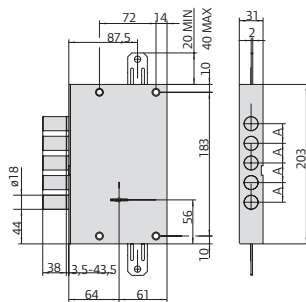

57500, 57501, 57502, 57505, 57506, 57507
A = 25 - 27 - 28 - 32 - 38

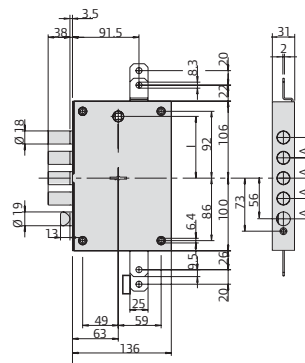

B7505, B7515
l = 85, A = 25-28-38

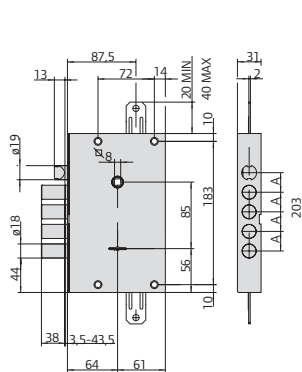

57510, 57511, 57512, 57515, 57516, 57517, 57518
A = 25 - 27 - 28 - 32 - 38

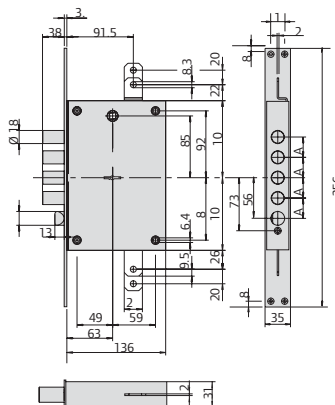

B7525, B7535
A = 28-38

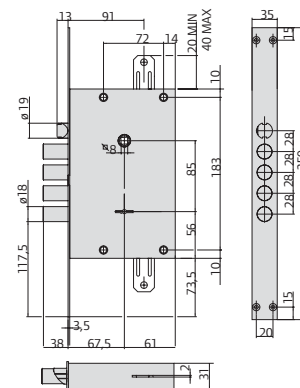

57530, 57531, 57535, 57536



Ingersoll Rand's Security Technologies Sector is a leading global provider of products and services that make environments safe, secure and productive. The sector's market-leading products include electronic and biometric access-control systems; time-and-attendance and personnel scheduling systems; mechanical locks; portable security; door closers, exit devices, architectural hardware, and steel doors and frames; and other technologies and services for global security markets.

www.ingersollrand.com

CISA SpA
Via Oberdan, 42
48018 Faenza (RA) Italy
Tel. +39 0546 677111
Fax +39 0546 677150
www.cisa.com