



Cylinders and keys







Cylinders and keys

When you talk about security, you talk about CISA.

Since 1926, the company has been producing mechanical and electronic locks, panic exit devices, door closers, padlocks, safes, keys and cylinders. CISA is part of Ingersoll Rand, one of the world's leading multinational companies, which specialises in integrated refrigeration systems, compressed air systems and security.

CISA, currently present in over 70 countries, has 6 production plants. The 40,000 m² plant in Monsampolo (AP) and the division specialised in producing master-keyed systems in Faenza (RA), are entirely dedicated to manufacturing over 18 million cylinders a year.

CISA cylinders and keys are fruit of the work of research and innovation aimed at satisfying the demands of end users and guaranteeing excellence. This brochure features a complete range of cylinders.

Solutions designed to provide the right answer to any request for security and access management systems.





Since time immemorial, cylinders and keys have evoked fundamental values and needs for man: security, protection and control. The choice of a cylinder is essential for protecting our homes, our personal values and for our tranquillity.





Master keyed systems, the simple, economic solution for managing access to complex set ups like hospitals, shopping centres, companies and universities. CISA offers a vast range of cylinders compatible with different locks (rim, PC and Elettrika), panic exit devices, padlocks and micro-switch cylinders, so any kind of entrance can be controlled. Moreover, CISA places instruments and experts for managing each and every stage of a project at a client's disposal: from consultancy to feasibility studies, offers to After Sales assistance.



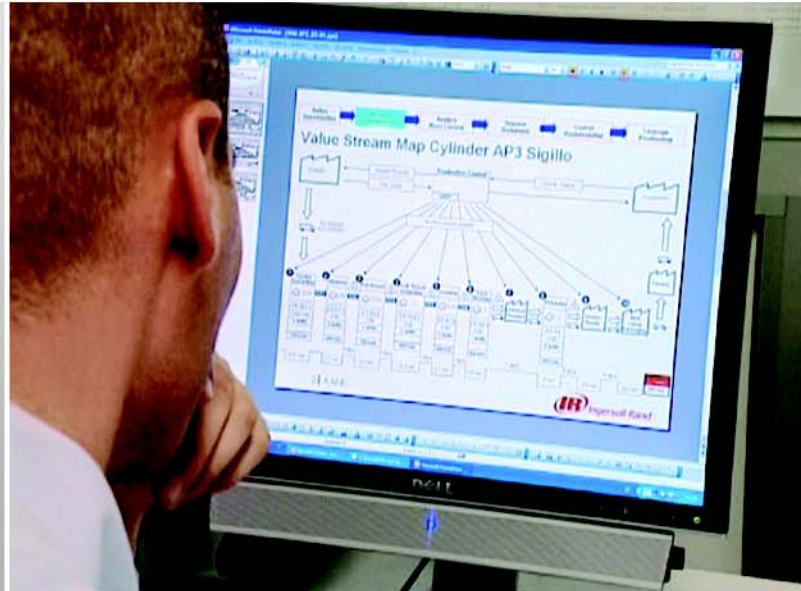

The Monsampolo (AP) plant is our key and cylinder centre par excellence. Top quality is the result of R&D carried out on both products and processes in order to improve continuously. The Quality System is certified according to UNI EN ISO 9001:2000.

The range

RS3 S



REVERSIBLE KEY CYLINDERS

AP3 S



Astral S



Astral



Asix



Cylinders and keys are the heart of security and access control

Cylinders and keys have always meant protection of the places in which we live. For this reason, fitting every door and opening with a secure, reliable cylinder is a prime requirement for anyone, and not only. Today, companies must respond to increasing demand for controlling and managing accesses by offering solutions and providing experts able to recommend and supply master keyed systems for houses, companies, hospitals, universities or shopping centres. Said experts must also be able to install products, and provide all the necessary assistance.

It is, therefore, essential for retailers and installers to be able to single out the most appropriate solution for different contexts of use.

CISA is the heart of every solution

With its vast range of cylinders, featuring either conventional or reversible keys, CISA is able to satisfy all demands for access security and management, a fundamental aspect for earning our clients' trust.

CONVENTIONAL KEY CYLINDERS

TSP



SP



08710



C2000



Knowing how to choose

In order to choose the most suitable kind of cylinder for your requirements, you simply have to know and measure three parameters: security, master keying potential and reliability. Security and reliability are based on European Standard EN1303 dated July 2005.

– security

indicates the cylinder's ability to resist and prevent forced entries (Attack Resistance according to EN1303), and the key's ability to prevent duplication and cloning (Key Related Security according to EN1303);

– master keying potential

indicates the performance, such as the number of pins in the key biting system and, therefore, the number of possible combinations the cylinder can offer to produce master keyed systems for managing accesses;

– reliability

indicates the level of resistance of the cylinder over the years and to wear and tear, expressed in the number of opening and closing cycles (Durability according to EN1303).



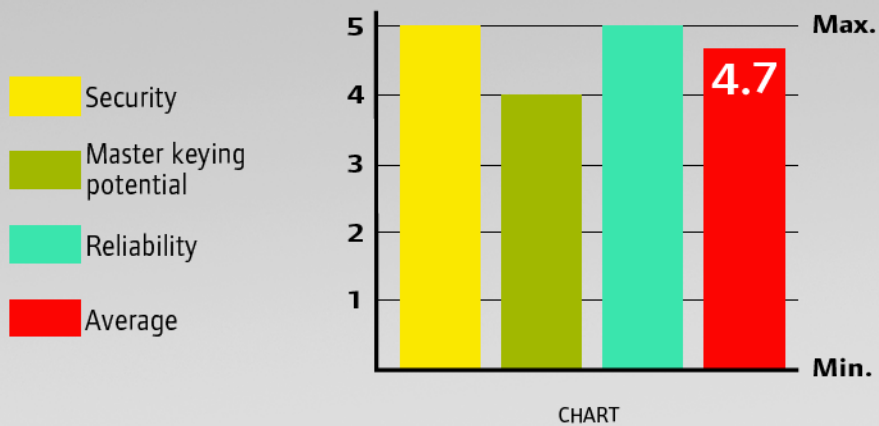

Every parameter is shown on the chart CISA has produced for each cylinder. The score from 1 (min) to 5 (max) indicates the performance level of each individual cylinder. The score of each parameter contributes to calculating the final, average parameter. The higher the score, the greater the cylinder performance level. It is possible to make a choice based on individual parameters or on an average score. For example, clients requiring a high security cylinder will read the specific parameters only, looking for those with the highest scores. If a high security cylinder and high master keying potential is required, on the other hand, they will read the average score.

How to choose

EUROPEAN STANDARD EN1303

European Standard EN1303 dated July 2005 sets forth the operation and requirements relating to the security and reliability of cylinders and their original keys.

Cylinder security - Attack Resistance

Cylinder security, expressed in 3 grades (from 0 to 2), establishes its resistance to brutal attacks, for example, piercing using a drill, breakage and removal.

Key security - Key Related Security

Key security, expressed in 6 grades (from 1 to 6), establishes the number of possible differs, that is, of different keys which can be produced by the key bitting system.

Reliability - Durability

Reliability is expressed in 3 grades (from 4 to 6) and based on the number of cycles (25 thousand to 100 thousand) the cylinder must guarantee.

A cycle is one opening and one closure.

The higher the grade, the greater the performance.

Attack Resistance

0 1 2

Key Related Security

1 2 3 4 5 6

Durability

4 5 6



ICIM CERTIFIED CYLINDERS IN CONFORMITY WITH EN1303

In July 2003, CISA became the very first company in Italy to obtain **EN1303** based, **ICIM** certification.

Certification guarantees cylinder performance ascertained through documental checks of the technical specifications, in-company inspections to control production process, taking of samples to test either in the company or on the market and, most importantly, yearly inspections.

This is so much more than a simple test report, which determines the performance of only a few cylinders at one specific time.

Certified cylinders Astral S, AP3 S and RS3 S fully guarantee respect for the performance declared according to EN1303, over the years.



THE ADVANTAGES OF CERTIFICATION

Are you:

An armoured door manufacturer?

Faster and cheaper to certify armoured doors according to the draft EN1627 standard.

The certificate makes tests on the cylinder unnecessary.

Distributor or installer?

More clarity and incisiveness in proposals, and fewer risks of the door degrading due to replacement of the cylinder supplied.

End user?

Greater guarantee compared with the performance declared by the supplier. Greater certainty that the door will maintain the same security performance should the cylinder be replaced.

Simply choose a cylinder featuring Attack Resistance and Key Related Security grades which are the same or higher than those of the cylinder supplied.

RS3 S

The most advanced security and master keying potential – only at CISA



CERTIFICATES

- ICIM EN 1303:05 16010C62 - Europe
Attack Resistance: grade 2
Key Related Security: grade 6
Durability: grade 6
- Ghost - Russia

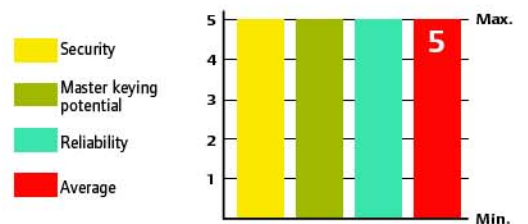

PATENTS

Key: patent pending
Utility model: B02003U000006 (Snap resistant feature)

RS3 S is the very best CISA offers, and ideal for high security applications for residential use and the armoured door industry. It is perfect for access management in companies, shopping centres, universities and hospitals with complex hierarchical structures.

CYLINDER SECURITY

- High resistance to tearing thanks to the Snap resistant feature, a dual-material steel core visible when the cylinder is installed in the door.
- It is impossible to obtain key blanks, difficult to tamper with the existing bitted key to obtain a “power key” and the high number of small pins set out radially.
- High resistance to the housebreaking technique with imprints or wax, thanks to the number of small pins and the fact they are laid out radially.
- High drill resistance, due to the key biting system (pins and drivers) in hardened steel.

EN1303: 2005 **Attack Resistance: 2**



KEY SECURITY

- Patented key, protected against illegal production.
- More difficult to clone as it is equipped with a mobile part.
- Security Card for the authorised duplication of the keys, which can only be carried out by CISA.
- Radial key biting system, up to 19 pins on 5 rows.
- Up to 8 billion possible combinations, that is different keys.

EN1303: 2005 **Key Related Security: 6**



MASTER KEYING POTENTIAL

- Maximum capacity, thanks to the radial key biting system, up to 19 pins on 5 rows.
- Up to 85 million different cylinders per master key, to solve different access management requirements. Other configurations available on request.

RELIABILITY

Tested to max. 100,000 cycles.

EN1303: 2005 **Durability: 6**

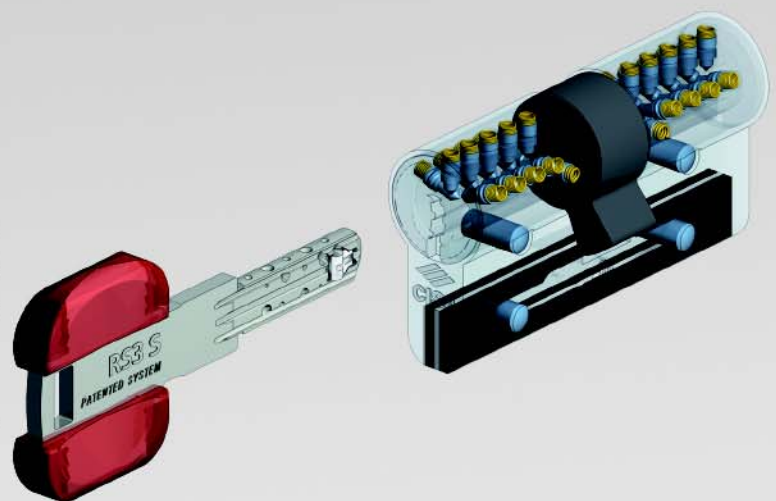
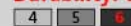

DISTINCTIVE FEATURES

- Keys can only be duplicated by CISA on presentation of the Security Card.
- Key more difficult to clone due to the new shape of the mobile part.
- New Ali grip, transparent beauty for total soundness and convenience.
- Almost limitless master keying potential.
- RS3 S is compatible with RS3. The new RS3 S key enters the RS3 cylinder, but not vice-versa.
- Tear and Snap resistant.
- High resistance to “bumping” or percussion.
- Emergency function, thanks to the clutch system supplied.
- Certified Attack Resistance grade 2, for classified armoured doors from 4 to 6 according to the EN1627 project.

AP3 S

High security, excellent master keying potential capacity and a local, highly professional service (CISA Solution Partner)



CERTIFICATES

- ICIM EN 1303:05 16010C62 - Europe
Attack Resistance: grade 2
Key Related Security: grade 6
Durability: grade 6
- SKG** - Holland
- Ghost - Russia



PATENTS

Key: PCT/EP99/07611
Utility model: B02003U000006 (Snap resistant feature)
BKP: registered patent

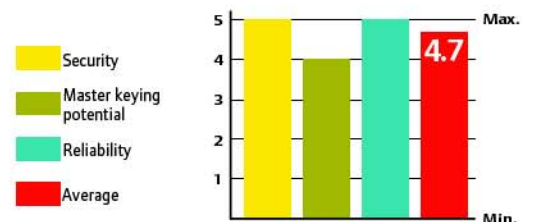

AP3 S has been specifically designed for high security applications for residential use and the armoured door industry. It offers excellent access management potential for companies, shopping centres, universities and hospitals.

CYLINDER SECURITY

- High resistance to tearing thanks to the Snap resistant feature, a dual-material steel core visible when the cylinder is installed in the door.
- High resistance to “bumping” or percussion, thanks to the BKP (Bump Key Power) device.
- High resistance to the housebreaking technique with imprints or wax, thanks to BKP and to the special shape of the springs.
- High drill resistance, thanks to the key biting system (all the pins and drivers and the inserts set out on both sides of the cylinder) in hardened steel.

EN1303: 2005 **Attack Resistance: 2**

0	1	2
---	---	---

KEY SECURITY

- Patented key, protected against illegal production.
- More difficult to clone thanks to the sprung, mobile part.
- Security Card for authorised key duplication by CISA Solution Partners and CISA.
- 11 pin key biting system on 3 rows.
- Up to 40 million possible combinations, that is different keys, including mechanical profiles.

EN1303: 2005 **Key Related Security: 6**

1	2	3	4	5	6
---	---	---	---	---	---

MASTER KEYING POTENTIAL

The 11 pin key biting system offers excellent access management capacity. For example, 132,000 different cylinders per master key.

RELIABILITY

Tested to max. 100,000 cycles.

EN1303: 2005 **Durability: 6**

4	5	6
---	---	---

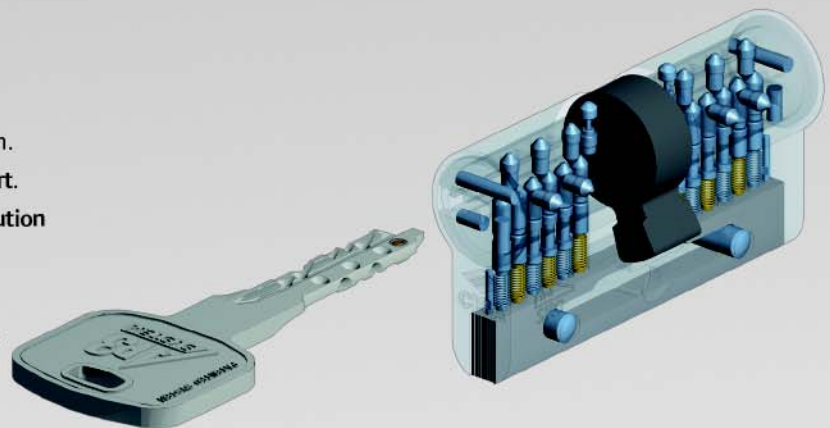

DISTINCTIVE FEATURES

- Key duplication only by CISA Solution Partners and CISA, on presentation of the Security Card.
- Key more difficult to clone thanks to the sprung, mobile part.
- Ali grip, transparent beauty for total soundness and convenience.
- Excellent master keying potential capacity.
- Tear and Snap resistant.
- BKP, high resistance to “bumping” or percussion.
- Attack Resistance grade 2 Certificate, for armoured doors classified 4 to 6 according to the draft EN1627 standard.

CISA Solution Partner is the CISA security network. CISA places training structures and innovative software instruments for producing master-keyed systems at the disposal of these professionals. Consequently, CISA Solution Partners are able to offer a highly professional duplication and master keying service and support clients in their choice of personalised, innovative solutions.



Astral S

Security and excellent master keying potential capacity



CERTIFICATES

- ICIM EN 1303:05 16010C61 - Europe
Attack Resistance: grade 1
Key Related Security: grade 6
Durability: grade 6
- Ghost - Russia

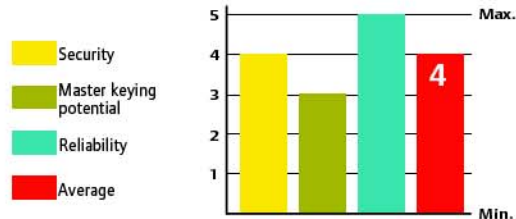

PATENTS

Utility model: B02003U000006 (Snap resistant feature)
BKP: registered patent

Astral S is ideal for average security applications: residences, armoured doors industry, shops and small offices.

CYLINDER SECURITY

- High resistance to tearing, thanks to the Snap resistant feature, a dual-material steel core visible when the cylinder is installed in the door.
- High resistance to “bumping” or percussion thanks to the BKP (Bump Key Power) device.
- High resistance to the housebreaking technique with imprints or wax, thanks to BKP and to the special shape of the springs.
- High drill resistance, thanks to the key biting system, (all the pins and drivers and the inserts set out on both sides of the cylinder) in hardened steel.

EN1303: 2005 **Attack Resistance: 1**



KEY SECURITY

- 10 pin key biting system on 2 rows.
- Over 1,600,000 possible combinations, that is different keys.

EN1303: 2005 **Key Related Security: 6**



MASTER KEYING POTENTIAL

The 10 pin key biting system offers excellent access management capacity. For example, 63,000 different cylinders per master key.

RELIABILITY

Tested to max. 100,000 cycles.

EN1303: 2005 **Durability: 6**

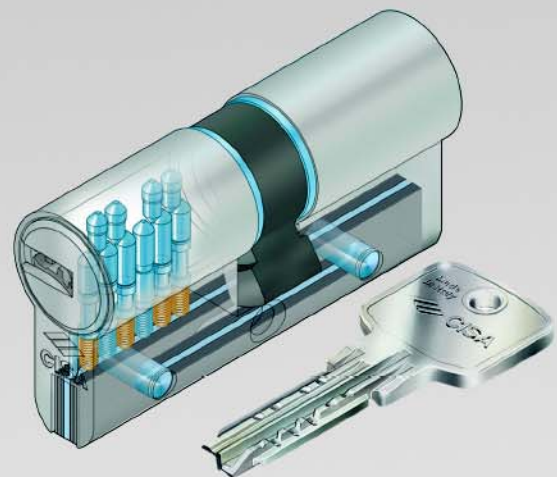
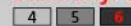

DISTINCTIVE FEATURES

- Snap resistant, high resistance to tearing and snapping.
- BKP, high resistance to “bumping” or percussion.
- Emergency function, thanks to the clutch system supplied.
- Excellent master keying potential capacity.
- Attack Resistance grade 1 Certificate, for armoured doors classified 1 to 3 according to the draft EN1627 standard.

Astral

Average security and excellent master keying potential capacity



Compliant with EN 1303:2005
 Attack Resistance: grade 0
 Key Related Security: grade 6
 Durability: grade 6

CERTIFICATE
 Ghost - Russia

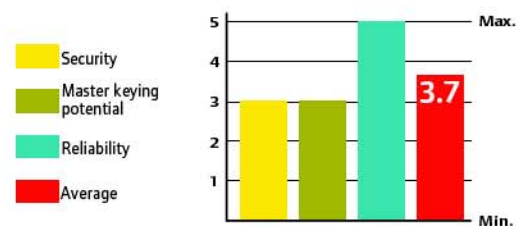

Astral can be used on average security armoured doors, but is most suited to the access management of companies, shopping centres, universities and hospitals, thanks to its excellent master keying potential capacity.

CYLINDER SECURITY

- Drill resistance, with first pin and driver and the inserts set out on both sides of the cylinder in hardened steel.
- High resistance to the housebreaking technique with imprints or wax, thanks to the special shape of the springs.

EN1303: 2005 **Attack Resistance: 0**

0	1	2
---	---	---

KEY SECURITY

- 10 pin key biting system on 2 rows.
- Over 1,600,000 possible combinations, that is different keys.

EN1303: 2005 **Key Related Security: 6**

1	2	3	4	5	6
---	---	---	---	---	---

MASTER KEYING POTENTIAL

The 10 pin key biting system offers excellent access management capacity. For example, 63,000 different cylinders per master key.

RELIABILITY

Tested to max. 100,000 cycles.

EN1303: 2005 **Durability: 6**

4	5	6
---	---	---

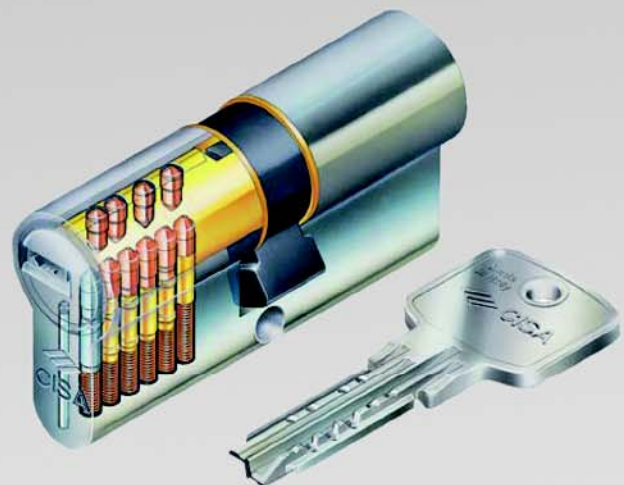

DISTINCTIVE FEATURES

- Excellent master keying potential capacity.

Asix

For basic security



Compliant with EN 1303:2005
 Attack Resistance: grade 0
 Key Related Security: grade 5
 Durability: grade 6

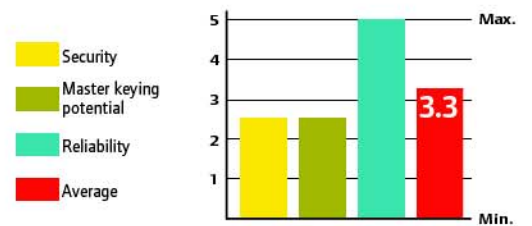

Asix can be used for entrances of secondary importance in shops, houses and blocks of flats, whenever basic security is required.

CYLINDER SECURITY

– Drill resistance, with first pin and driver in hardened steel.

EN1303: 2005 **Attack Resistance: 0**

0	1	2
---	---	---

RELIABILITY

Tested to max. 100,000 cycles.

EN1303: 2005 **Durability: 6**

4	5	6
---	---	---

KEY SECURITY

– 6 pin key biting system.

– Over 30,000 possible combinations, that is different keys.

EN1303: 2005 **Key Related Security: 5**

1	2	3	4	5	6
---	---	---	---	---	---

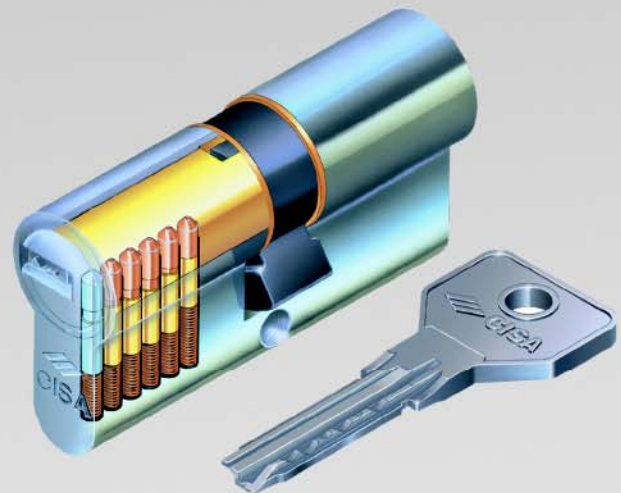

TSP

Good security and duplication performance



Compliant with EN 1303:2005
Attack Resistance: grade 0
Key Related Security: grade 6
Durability: grade 6

PATENTS

Key protected by shape registered trademark 3.754.504

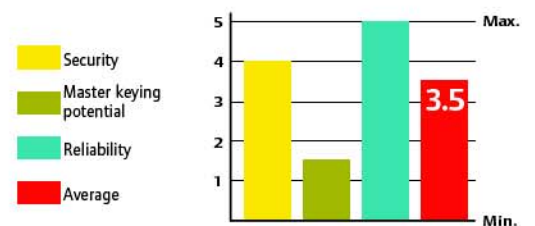

TSP is ideal for residential use and in shops.

CYLINDER SECURITY

- High resistance to “bumping” or percussion thanks to BKP (Bump Key Power) device.
- High drill resistance, thanks to the 2 hardened steel inserts set out on both sides of the cylinder body, and 2 inserts in both plugs.

EN1303: 2005 **Attack Resistance: 0**

0	1	2
---	---	---

KEY SECURITY

- Key protected by shape registered trademark and against illegal production.
- High picking resistance, thanks to the special shape of the key, and active lateral pins.
- 13 pin key biting system on 3 rows.
- Over 7,000,000 possible combinations, that is different keys.
- Can only be duplicated by CISA or its Authorised Centres on presentation of the Security Card supplied, to guarantee maximum security against improper duplication.

EN1303: 2005 **Key Related Security: 6**

1	2	3	4	5	6
---	---	---	---	---	---

RELIABILITY

Tested to max. 100,000 cycles.

EN1303: 2005 **Durability: 6**

4	5	6
---	---	---

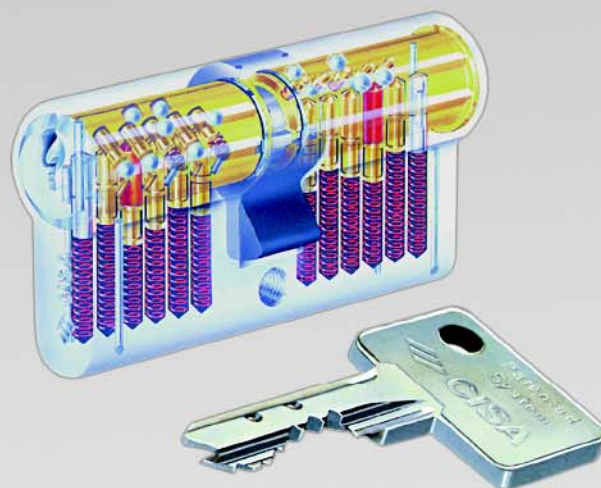

DISTINCTIVE FEATURES

- Keys can only be duplicated by CISA or its Authorised Centres on presentation of the Security Card.
- BKP, high resistance to “bumping” or percussion.
- High picking resistance thanks to the special shape of the key and active lateral pins.

SP

Good security performance



Compliant with EN 1303:2005
 Attack Resistance: grade 0
 Key Related Security: grade 6
 Durability: grade 6

PATENTS

Key protected by shape registered trademark 3.754.504

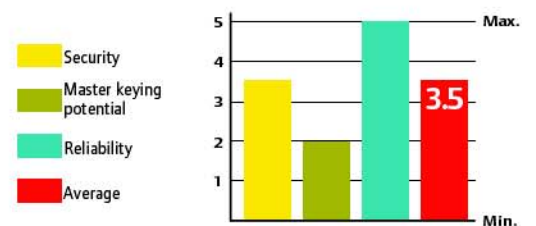

SP, for residential use and shops.

CYLINDER SECURITY

- High resistance to “bumping” or percussion thanks to the BKP (Bump Key Power) device.
- High drill resistance, thanks to the 2 hardened steel inserts set out on both sides of the cylinder body, and 2 inserts in both plugs.

EN1303: 2005 **Attack Resistance: 0**

0	1	2
---	---	---

KEY SECURITY

- Key protected by shape registered trademark and against illegal production.
- High picking resistance, thanks to the special shape of the key.
- 10 pin key biting system on 3 rows.
- Over 7,000,000 possible combinations, that is different keys.

EN1303: 2005 **Key Related Security: 6**

1	2	3	4	5	6
---	---	---	---	---	---

RELIABILITY

Tested to max. 100,000 cycles.

EN1303: 2005 **Durability: 6**

4	5	6
---	---	---

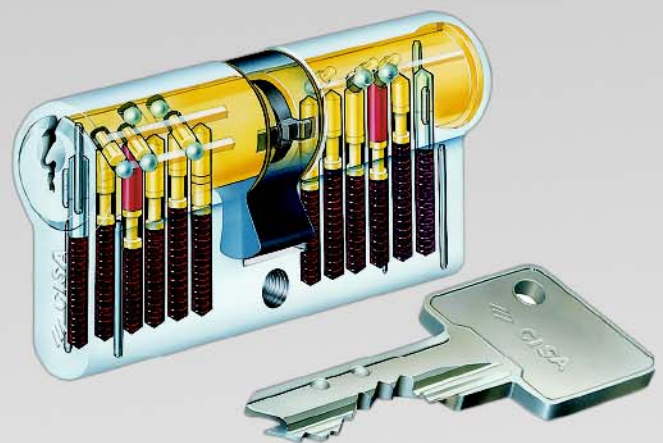

DISTINCTIVE FEATURES

- BKP, high resistance to “bumping” or percussion.
- High picking resistance, thanks to the special shape of the key.

08710

Security for entrances of secondary importance



08710 can be used for entrances of secondary importance in shops, houses and blocks of flats whenever basic security is required.

CYLINDER SECURITY

– Drill resistance, first pin and driver in hardened steel.

EN1303: 2005 **Attack Resistance: 0**



KEY SECURITY

– 5 pin key bitting system, 0.65 mm rise.

– Over 3,600 possible combinations, that is different keys.

EN1303: 2005 **Key Related Security: 3**



RELIABILITY

Tested to max. 100,000 cycles.

EN1303: 2005 **Durability: 6**

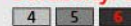

Compliant with EN 1303:2005

Attack Resistance: grade 0

Key Related Security: grade 3

Durability: grade 6

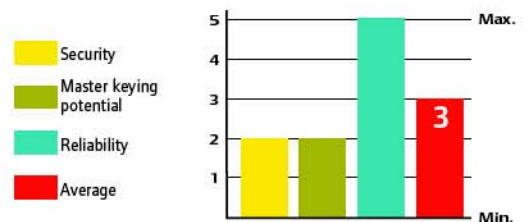

C2000

Basic security and good master keying potential capacity



Good capacity for the management of accesses of secondary importance in companies, shopping centres, universities and hospitals.

CYLINDER SECURITY

– Drill resistance, with first pin and driver in hardened steel.

EN1303: 2005 **Attack Resistance: 0**
0 1 2

KEY SECURITY

– 5 pin key biting system, 0.44 mm rise.
 – Over 30,000 possible combinations, that is different keys.

EN1303: 2005 **Key Related Security: 4**
1 2 3 4 5 6

RELIABILITY

Tested to max. 100,000 cycles.

EN1303: 2005 **Durability: 6**
4 5 6

Compliant with EN 1303:2005
 Attack Resistance: grade 0
 Key Related Security: grade 4
 Durability: grade 6

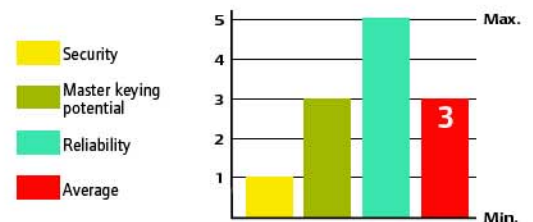

Quick guide to choosing a cylinder

CHOOSE YOUR APPLICATION	CHOOSE YOUR REQUIRED LEVEL OF SECURITY	CHOOSE YOUR REQUIRED LEVEL OF MASTER KEYING POTENTIAL	RS3 S	AP3 S	Astral S	Astral	Asix
ARMoured DOORS INDUSTRY	S	S					•
	M/A	M/A			•	•	
	A/H	M/A	•	•			
RESIDENCES	S	S					
	M/A	M/A			•		
	A/H	M/A	•	•			
SHOPS SMALL OFFICES	S	-					•
	M/A	-			•		
	A/H	-	•	•			
HOSPITALS UNIVERSITIES SHOPPING CENTRES COMPANIES	S	S					
	M/A	M/A				•	
	A/H	M/A		•			
	A/H	A/H	•				

S = Standard **M/A** = Average **A/H** = High

CHOOSE YOUR APPLICATION	CHOOSE YOUR REQUIRED LEVEL OF SECURITY	CHOOSE YOUR REQUIRED LEVEL OF MASTER KEYING POTENTIAL	TSP	SP	08710	C2000
ARMOURED DOORS INDUSTRY	S	S				
	M/A	M/A				
	A/H	M/A				
RESIDENCES	S	S				•
	M/A	M/A		•		
	A/H	M/A	•			
SHOPS SMALL OFFICES	S	-			•	
	M/A	-		•		
	A/H	-	•			
HOSPITALS UNIVERSITIES SHOPPING CENTRES COMPANIES	S	S				•
	S	M/A				•*
	A/H	M/A				
	A/H	A/H				

S = Standard M/A = Average A/H = High * = With complementary keyway sections

Summary

		RS3 S	AP3 S	Astral S	Astral	Asix
KEY TYPE	Conventional					
	Reversible	•	•	•	•	•
	Long key for protective rose	•	•	• (CL and CP only)	• (CL and CP only)	•
CYLINDER SECURITY	Tearing and snapping	Snap Resistant	Snap Resistant	Snap Resistant		
	Bumping		BKP	BKP		
	Drill	• (hardened steel key biting system)	• (hardened steel key biting system)	• (hardened steel key biting system)		
KEY SECURITY	Patent	•	•			
	Shape registered trademark					
	Security Card	•	•			
	Authorised key duplication	• (CISA only)	• (CISA and CISA Solution Partners)			
	Key differs (including non active pins and inserts)	over 8 billion	over 40 million	over 1.6 million	over 1.6 million	over 30,000
MASTER KEYING POTENTIAL	X MK cylinders	85 million	132,000	63,000	63,000	1,800
	Type double cylinders	•	•	•	•	•
	single cylinders	•	•	•	•	•
	thumb turn shaft	•	•	•	•	•
	for padlocks	•	•	•	•	
	for rim locks	•	•	•	•	
	for PC and Elettrika locks	•	•	•	•	•
	for panic exit devices	•	•	•	•	•
	with microswitch	•	•	•	•	
	with deadbolt	•	•	•	•	
EN1303 STANDARD	Attack Resistance	2	2	1	0	0
	Key Related Security	6	6	6	6	5
	Durability	6	6	6	6	6
CERTIFICATES	ICIM EN1303	•	•	•		
	SKG**		•			
	GHOST	•	•	•	•	•

■ Security
 ■ Master keying potential
 ■ Reliability
 ■ Average



		TSP	SP	08710	C2000
KEY TYPE	Conventional	•	•	•	•
	Reversible				
	Long key for protective rose	• (CL only)	• (CL only)		•
CYLINDER SECURITY	Tearing and snapping				
	Bumping	BKP	BKP		
	Drill				
KEY SECURITY	Patent				
	Shape registered trademark	•	•		
	Security Card	•			
	Authorised key duplication	• (CISA and Authorised Centres)			
	Key differs (including non active pins and inserts)	7 million	7 million	over 3,600 million	over 30,000 million
MASTER KEYING POTENTIAL	X MK cylinders	300	300	1,000	1,000
	Type double cylinders	•	•	•	•
	single cylinders	•	•	•	•
	thumb turn shaft	•	•	•	•
	for padlocks	•	•	•	•
	for rim locks	•	•	•	•
	for PC and Elettrika locks	•	•	•	•
	for panic exit devices	•	•	•	•
	with microswitch	•	•	•	•
	with deadbolt	•	•	•	•
EN1303 STANDARD	Attack Resistance	0	0	0	0
	Key Related Security	6	6	3	4
	Durability	6	6	6	6
CERTIFICATES	ICIM EN1303				
	SKG**				
	GHOST				

■ Security
 ■ Master keying potential
 ■ Reliability
 ■ Average

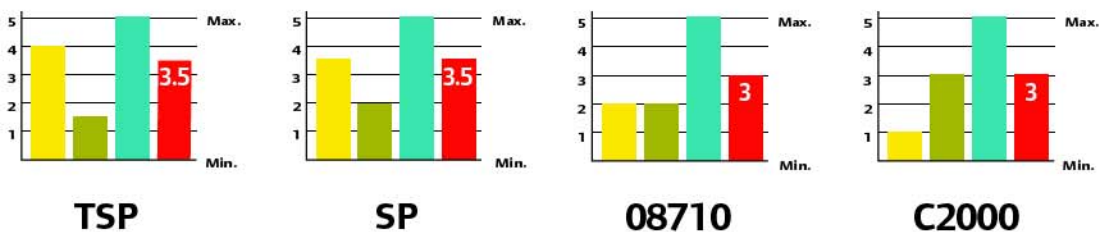



Ingersoll Rand's Security Technologies Sector is a leading global provider of products and services that make environments safe, secure and productive. The sector's market-leading products include electronic and biometric access-control systems; time-and-attendance and personnel scheduling systems; mechanical locks; portable security; door closers, exit devices, architectural hardware, and steel doors and frames; and other technologies and services for global security markets.

CISA SpA
Via Oberdan, 42
48018 Faenza (RA) Italy
Tel. +39 0546 677111
Fax +39 0546 677150
www.cisa.com

www.ingersollrand.com